

DCT 531

Industrial Pressure Transmitter with RS485 Modbus RTU

Stainless Steel Sensor

accuracy according to IEC 60770:
standard: 0.35 % FSO
option: 0.25 % FSO



Nominal pressure

from 0 ... 100 mbar up to 0 ... 400 bar

output signal

RS485 with Modbus RTU protocol

Special characteristic

- ▶ perfect thermal behaviour
- ▶ excellent long term stability

Optional versions

- ▶ pressure port
G 1/2" flush from 100 mbar
- ▶ pressure sensor welded
- ▶ customer specific versions

The DCT 531 with RS485 interface uses the communication protocol Modbus RTU which has found the way in industrial communication as an open protocol. The Modbus protocol is based on a master Slave architecture with which up to 247 Slaves can be questioned by a master – the data will transfer in binary form.

Due to the usage of high quality materials and components, the DCT 531 is suitable for almost every industrial application, if medium is compatible with stainless steel 316L.

The modular concept of the pressure transmitter allows customized electrical or mechanical connections, so it is easy to adapt the DCT 531 to different conditions on-site.

Preferred areas of use are



Plant and Machine Engineering



Energy Industry



Input pressure range													
Nominal pressure gauge	[bar]	-1...0	0.10	0.16	0.25	0.40	0.60	1	1.6	2.5	4	6	
Nominal pressure abs.	[bar]	-	-	-	-	0.40	0.60	1	1.6	2.5	4	6	
Overpressure	[bar]	5	0,5	1	1	2	5	5	10	10	20	40	
Burst pressure \geq	[bar]	7.5	1.5	1.5	1.5	3	7.5	7.5	15	15	25	50	
Nominal pressure gauge / abs.	[bar]	10	16	25	40	60	100	160	250	400			
Overpressure	[bar]	40	80	80	105	210	600	600	1000	1000			
Burst pressure \geq	[bar]	50	120	120	210	420	1000	1000	1250	1250			
Vacuum resistance		$P_N \geq 1$ bar: unlimited vacuum resistance $P_N < 1$ bar: on request											
Output signal													
Digital (pressure)		RS 485 with Modbus RTU protocol											
Supply													
Direct current		$V_S = 9 \dots 32 V_{DC}$											
Performance													
Accuracy ¹		standard for $P_N \geq 0.4$ bar: $\leq \pm 0.35$ % FSO standard for $P_N < 0.4$ bar: $\leq \pm 0.5$ % FSO option for $P_N \geq 0.4$ bar: $\leq \pm 0.25$ % FSO											
Long term stability		$\leq \pm 0.1$ % FSO / year at reference conditions											
Measuring rate		500 Hz											
¹ accuracy according to IEC 60770 – limit point adjustment (non-linearity, hysteresis, repeatability)													
Thermal effects (Offset and Span)													
Nominal pressure P_N	[bar]	-1 ... 0				< 0.40				≥ 0.40			
Tolerance band	[% FSO]	$\leq \pm 0.75$				$\leq \pm 1$				$\leq \pm 0.75$			
in compensated range	[°C]	-20 ... 85				0 ... 70				-20 ... 85			
Permissible temperatures													
Permissible temperatures		medium: -25 ... 125 °C electronics / environment: -25 ... 85 °C storage: -40 ... 85 °C											
Electrical protection													
Short-circuit protection		permanent											
Reverse polarity protection		by exchanged supply connections no damage, but also no function											
Electromagnetic compatibility		emission and immunity according to EN 61326											
Mechanical stability													
Vibration		10 g RMS (25 ... 2000 Hz) according to DIN EN 60068-2-6											
Shock		500 g / 1 msec according to DIN EN 60068-2-27											
Materials													
Pressure port / housing		stainless steel 1.4404 (316 L)											
Seals (media wetted)		standard: FKM options: EPDM welded version ² others on request											
Diaphragm		stainless steel 1.4435 (316 L)											
Media wetted parts		pressure port, seal, diaphragm											
² welded version only with pressure ports according to EN 837													
Miscellaneous													
Current consumption		typ. 7 mA											
Weight		approx. 210 g											
Installation position		any ³											
Operational life		$> 100 \times 10^6$ pressure cycles											
CE-conformity		EMC Directive: 2014/30/EU					Pressure Equipment Directive: 2014/68/EU (module A) ⁴						
³ Pressure transmitters are calibrated in a vertical position with the pressure connection down. If this position is changed on installation there can be slight deviations in the zero point for pressure ranges $P_N \leq 1$ bar.													
⁴ This directive is only valid for devices with maximum permissible overpressure > 200 bar													

DCT 531

Industrial Pressure Transmitter with RS485 Modbus RTU

Technical Data

Wiring diagrams

RS 485 / Modbus RTU

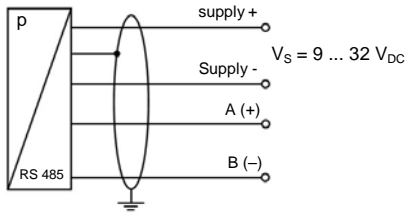

Pin configuration

Electrical connection	M12x1 / metal (4-pin)	Binder 723 (5-pin)	cable colour (IEC 60757)
Supply +	1	3	wh (white)
Supply -	3	4	bn (brown)
A +	2	1	gn (green)
B -	4	2	ye (yellow)
Shield	Pressure port	5	gnye (green-yellow)

Electrical connections (dimensions in mm)

standard

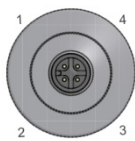
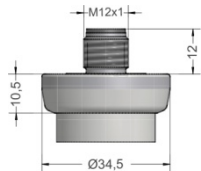

M12x1 4-pin (IP 67)

option

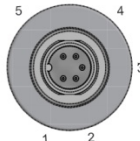
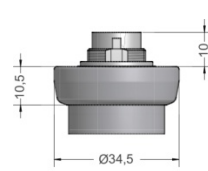

Binder Series 723 5-pin (IP 67)

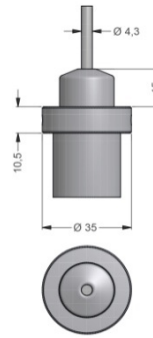

cable outlet with PVC cable (IP 67)⁵ (on request)

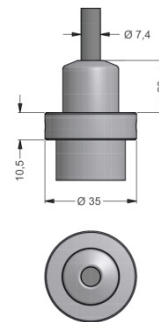

cable outlet, cable with ventilation tube (IP 68)⁶ (on request)

⁵ standard: 2 m PVC cable without ventilation tube (permissible temperature: -5 ... 70°C)

⁶ different cable types and lengths available, permissible temperature depends on kind of cable

Mechanical connections (dimensions in mm)

standard

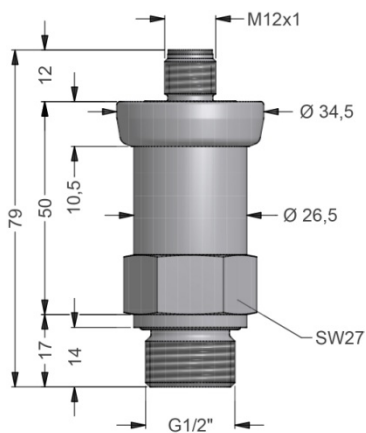

G1/2" DIN 3852 with M12x1

Mechanical connections (dimensions in mm)

option

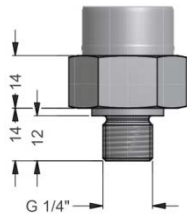

G1/4" DIN 3852

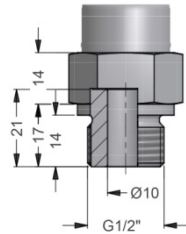

G1/2" open port

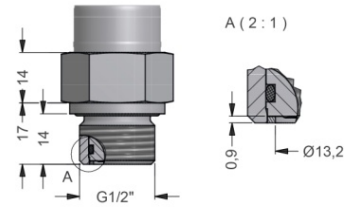

G1/2" DIN 3852
with flush sensor

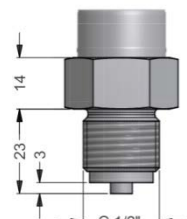

G1/2" EN 837

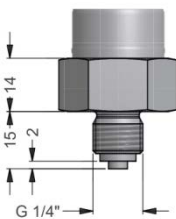

G1/4" EN 837

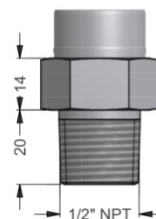

1/2" NPT

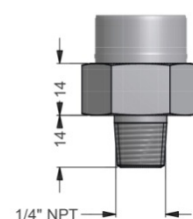

1/4" NPT

⇒ metric threads and other versions on request

Configuration Modbus RTU					
Standard configuration	001	-	1	-	1
Address					
address	001				
	...				
	247				
Baud Rate					
4800 Bd			0		
9600 Bd			1		
19200 Bd			2		
38400 Bd			3		
Parity					
None					0
Odd					1
Even					2

© 2016 BDSENSORS GmbH – The specifications given in this document represent the state of engineering at the time of publishing. We reserve the right to make modifications to the specifications and materials.

Ordering code DCT 531

DCT 531

□□□ - □□□□ - □ - □ - □□□ - □□□□ - □ - □□□□

Pressure		D	C	7														
	gauge	D	C	7														
	absolute ¹	D	C	8														
Input		[bar]																
	0.1	¹	1	0	0	0												
	0.16	¹	1	6	0	0												
	0.25	¹	2	5	0	0												
	0.4		4	0	0	0												
	0.6		6	0	0	0												
	1		1	0	0	1												
	1.6		1	6	0	1												
	2.5		2	5	0	1												
	4		4	0	0	1												
	6		6	0	0	1												
	10		1	0	0	2												
	16		1	6	0	2												
	25		2	5	0	2												
	40		4	0	0	2												
	60		6	0	0	2												
	100		1	0	0	3												
	160		1	6	0	3												
	250		2	5	0	3												
	400		4	0	0	3												
	-1 ... 0		X	1	0	2												
	customer		9	9	9	9												consult
Output		Modbus RTU																
							L5											
Accuracy																		
	standard for P _N ≥ 0.4 bar	0.35 %					3											
	standard for P _N < 0.4 bar	0.5 %					5											
	option for P _N ≥ 0.4 bar	0.25 %					2											
		0.1 %					1											consult
	customer						9											consult
Electrical connection																		
	Male plug M12x1 (4-pin) / metal						M	1	3									
	Male plug Binder series 723 (5-pin)						2	0	7									
	Cable outlet with PVC cable ²						T	A	0									consult
	Cable outlet (IP68) ³						T	R	0									consult
	customer						9	9	9									consult
Mechanical connection																		
	G1/2" DIN 3852						1	0	0									
	G1/2" EN 837						2	0	0									
	G1/4" DIN 3852						3	0	0									
	G1/4" EN 837						4	0	0									
	G1/2" DIN 3852 with flush sensor						F	0	0									
	G1/2" DIN 3852 open pressure port						H	0	0									
	1/2" NPT						N	0	0									
	1/4" NPT						N	4	0									
	customer						9	9	9									consult
Seals																		
	FKM													1				
	EPDM													3				
	without (welded version) ⁴													2				consult
	customer													9				consult
Special version																		
	standard													0	0	0		
	customer													9	9	9		consult

© 2016 BD|SENSORS GmbH - The specifications given in this document represent the state of engineering at the time of publishing. We reserve the right to make modifications to the specifications and materials.

15.03.2016

¹ absolute pressure possible from 0.4 bar
² standard: 2 m PVC cable without ventilation tube (permissible temperature: -5 ... 70°C), others on request
³ cable with ventilation tube (code TR0 = PVC cable), different cable types and lengths available, price without cable
⁴ welded version only with pressure ports according to EN 837

