

▶ MV SERIES MICRO SWITCHES

◆ FEATURES

- Small dimensions suitable for OEM uses.
- High temperature type, max 120°C.
- Wide choice of heads and actuators.
- Long life services.

◆ RATING

- Standard type
(UL recognized) UL認可
- 1) 5A 125 or 250VAC
- 2) 0.5A 125 or 250VDC
- High current type
- 1) 20A 125 or 250VAC
- 2) 0.5A 125 or 250VDC

◆ CIRCUITRY

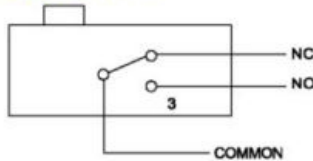

◆ REMARK

- MV-3003AL, MV-3003BL → Actuator length 55.5mm

◆ ORDER GUIDE

- Standard type:

MV-3000A	MV-3001A	MV-3002A	MV-3003A	MV-3004A	MV-3005A
MV-3003AL	MV-3004S	MV-001			

- Light force type:

MV-3000B	MV-3001B	MV-3002B	MV-3003B	MV-3004B	MV-3005B	MV-3003BL
----------	----------	----------	----------	----------	----------	-----------

- Plastic roller (Custom made):

MV-3004A-P	MV-3005A-P	MV-3004B-P	MV-3005B-P
------------	------------	------------	------------

- NC or NO type (Custom made):

MV-3000A-NC,NO	MV-3001A-NC,NO	MV-3002A-NC,NO	MV-3003A-NC,NO	MV-3004A-NC,NO	MV-3005A-NC,NO
MV-3000B-NC,NO	MV-3001B-NC,NO	MV-3002B-NC,NO	MV-3003B-NC,NO	MV-3004B-NC,NO	MV-3005B-NC,NO

- High temperature body 120°C (Custom made):

MV-3100	MV-3101	MV-3102	MV-3103	MV-3104	MV-3105
---------	---------	---------	---------	---------	---------

- High current type (Custom made):

MV-3000A20	MV-3001A20	MV-3002A20	MV-3003A20	MV-3004A20	MV-3005A20
MV-3000B20	MV-3001B20	MV-3002B20	MV-3003B20	MV-3004B20	MV-3005B20



● MV-001

◆ CHARACTERISTICS/特性

Operating speed	0.01mm to 1m/sec
Operating frequency	Mechanically: 600 operations/min. Electrically: 60 operations/min.
Contact resistance	15m Ω max. (initial)
Insulation resistance	100M Ω min. (at 500 VDC)
Dielectric strength	1,000 VAC, 50/60 Hz for 1 minute between non-continuous terminals 2,000 VAC, 50/60 Hz for 1 minute between current-carrying part and ground
Vibration	Malfunction durability: 10 to 55Hz 1.5mm double amplitude
Shock	Mechanical durability: Approx. 1,000m/sec ² (approx. 100G's) Malfunction durability: Approx. 300 m/sec ² (approx. 30 G's)
Ambient operating temperature	General purpose type: -25°C to +80°C High temperature type: 25°C to 120°C
Humidity	General purpose type: 85% RH max Sealed type: 95% RH
Service life	Mechanically: 5,000,000 operations min Electrically: 500,000 operations min.



● MV-3002



● MV-3005-P



● MV-3004S



● MV-3000-NC



● MV-3000



● MV-3003



● MV-3004



● MV-3003L



● MV-3001



● MV-3004-P



● MV-3005



● MV-3000-NO

ORDER GUIDE

DIMENSIONS (mm)

● MV-3000

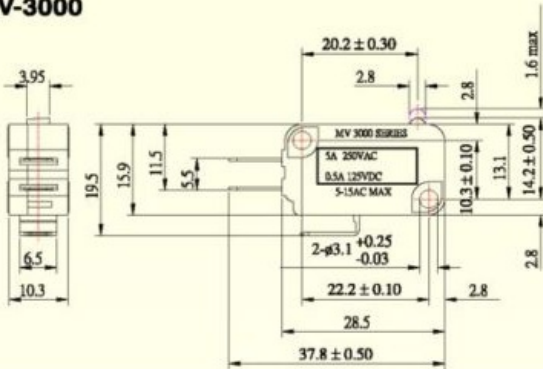

● MV-3001

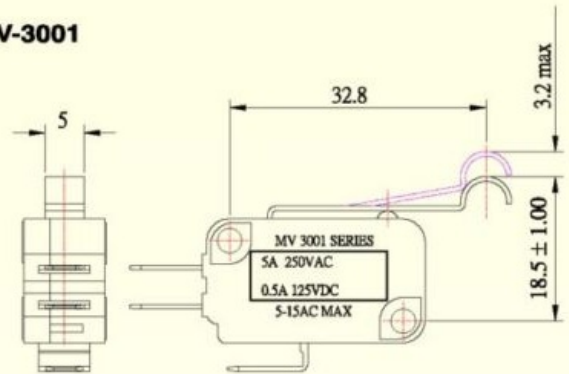

● MV-3002

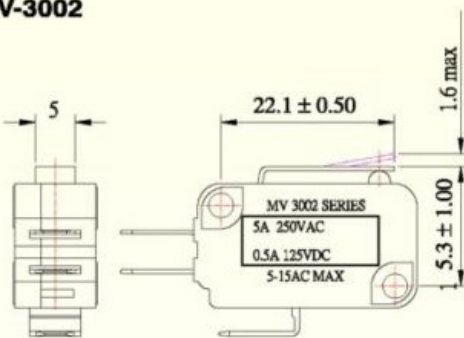

● MV-3003

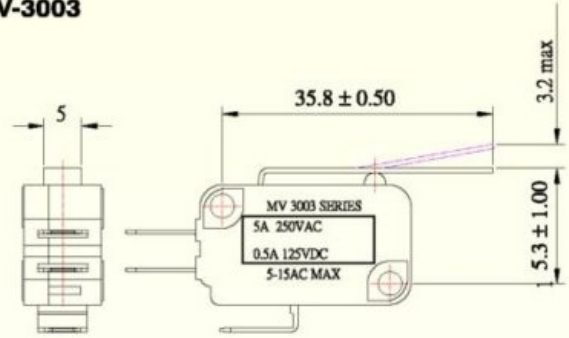

● MV-3004

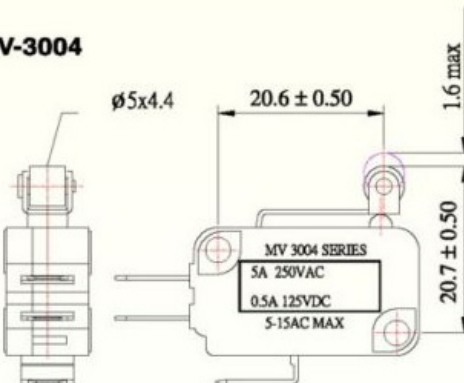

● MV-3005

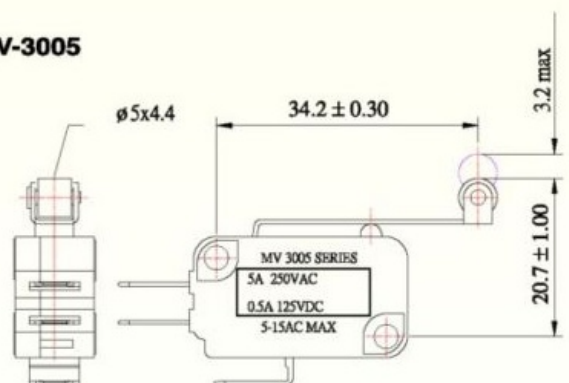

OPERATING CHARACTERISTICS

MV-3000	A	B
OF MAX	250g	100g
RF MIN	50g	25g
PT MAX	1.2mm	
OT MIN	1.0mm	
DT MAX	0.4mm	
OP	14.70 ± 0.4	

MV-3001	A	B
OF MAX	140g	60g
RF MIN	20g	10g
PT MAX	4.0mm	
OT MIN	1.6mm	
DT MAX	1.5mm	
OP	18.70 ± 1.2	

MV-3002	A	B
OF MAX	250g	100g
RF MIN	50g	25g
PT MAX	1.6mm	
OT MIN	0.8mm	
DT MAX	0.6mm	
OP	15.20 ± 0.5	

MV-3003	A	B
OF MAX	140g	60g
RF MIN	20g	10g
PT MAX	4.0mm	
OT MIN	1.6mm	
DT MAX	1.5mm	
OP	15.20 ± 1.2	

MV-3004	A	B
OF MAX	280g	110g
RF MIN	50g	20g
PT MAX	1.6mm	
OT MIN	0.8mm	
DT MAX	0.6mm	
OP	20.70 ± 0.6	

MV-3005	A	B
OF MAX	140g	60g
RF MIN	20g	10g
PT MAX	4.0mm	
OT MIN	1.6mm	
DT MAX	1.5mm	
OP	20.70 ± 1.2	