

METAL SPECIAL TYPES

Below items are custom-built subject to special application place and existed equipment facilities. Their unique characters as follow:

- Any size measuring range, but $\phi 8\text{mm}$ stem Max. 500mm.
- Customized mounting thread specification are acceptable.
- Single or multiple contact form (point) are workable.
- Switch activation N.O. or N.C. are available.

► FDSA□11

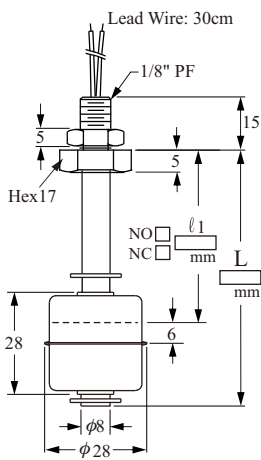

Washer: NBR

► FDSB□11

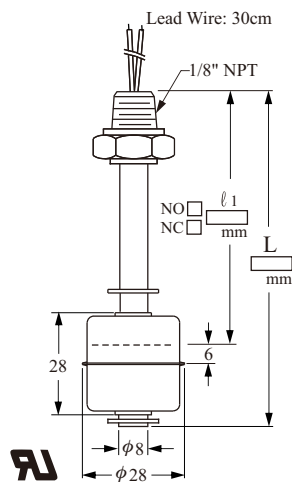

Washer: NBR

► FDSC□11

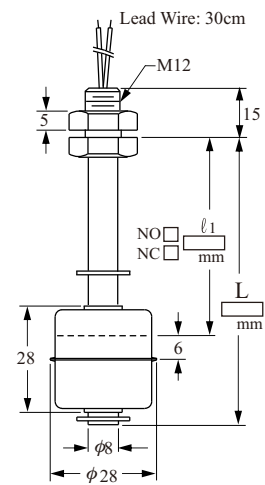

Washer: NBR

► FDSA□12

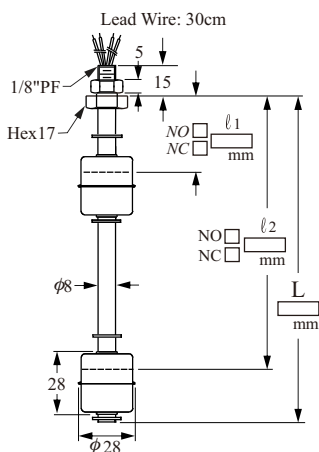

Washer: NBR

► FDSA□21

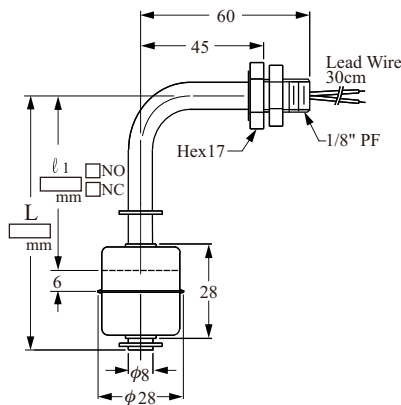

Washer: NBR

► FDSA□22

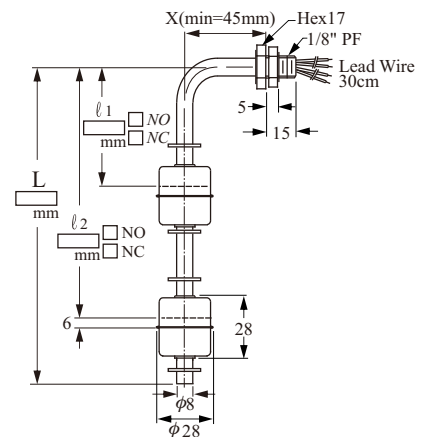

Washer: NBR

METAL SPECIAL TYPES

Below items are custom-built subject to special application place and existed equipment facilities. Their unique characters as follow:

- Any size measuring range.
- Customized mounting thread specification are acceptable.
- Single or multiple contact form (point) are workable.
- Switch activation N.O. or N.C. are available.

► FDS□11

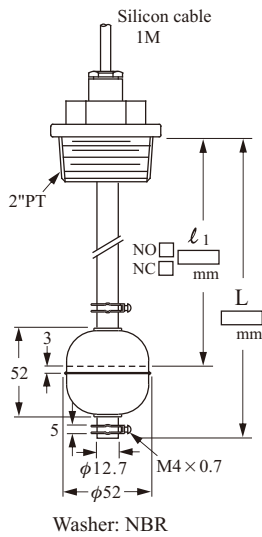

► FDSE□11

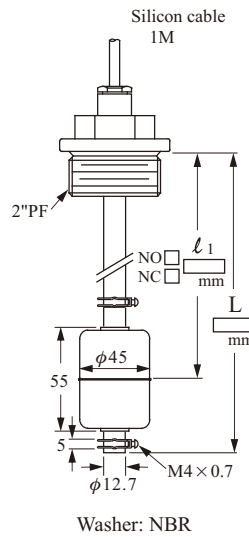

► FDSF□11

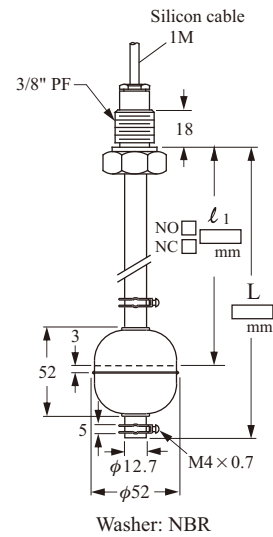

► FD4503D

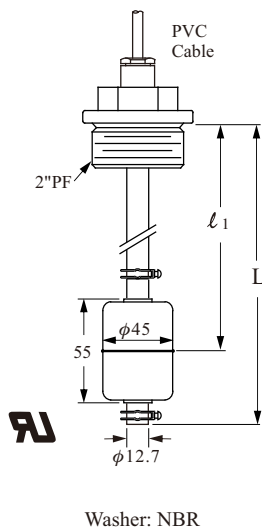

► FD5003G

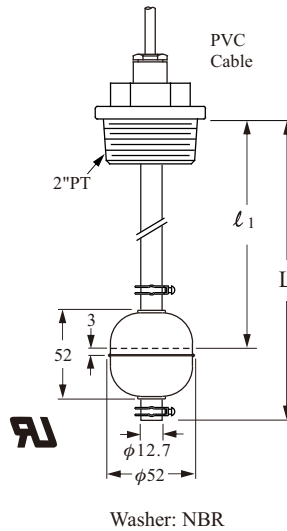

► FD7503G

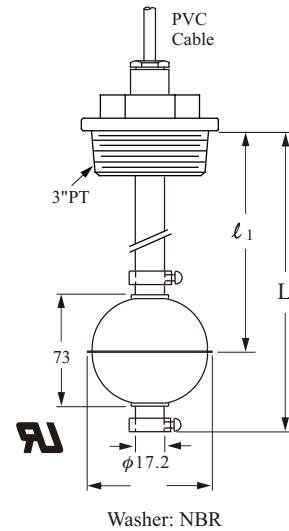

ORDER INFORMATION FOR METAL SPECIAL TYPE

FD S A 6 1 2 D A 0 5

Type _____

- FDSA** Float : **RF-SA** ϕ 28x28, Screw : 1/8"PF
- FDSB** Float : **RF-SB** ϕ 28x28, Screw : 1/8"NPT
- FDSC** Float : **RF-SC** ϕ 28x28, Screw : M12
- FSDS** Float : **RF-SD** ϕ 52x52, Screw : 2"PT
- FDSE** Float : **RF-SE** ϕ 45x55, Screw : 2"PF
- FDSF** Float : **RF-SF** ϕ 52x52, Screw : 3/8"PF

Material of Wetted parts _____

- 0** : SUS304
- 6** : SUS316

Mounting _____

- 1** : Top or Bottom Mourting
- 2** : Side Mounting

Float Number _____

1~4 floats

Switching Capacity Max. _____

- D**: 50W 240Vac /200Vdc, SPST
- G**: 60W 220Vac, SPDT (only use for tube ϕ 12.7)
- K**: 20W 150Vac /200Vdc, SPDT

Contact Form _____

- A**: Normal Open (N.O.) SPST **F** : 1 float 2 points
- B**: Normal Close (N.C.) SPST **H**: 1-N.O.,1-N.C.(2 floats)
- C**: 1AB SPDT

Lead wire Length (Unit=100mm) _____

- 03**: 300mm (SA, SB, SC, Standard length) ※ 500mm per Unit
- 05**: 500mm (below 500mm)
- 10**: 1000mm (SD, SE, SF, Standard length)
- 15**: 1500mm (1001~1500mm)

Material of Lead wire _____

- C**: PVC cable (80°C) ---- AWG22 X 2C X ϕ 4
 - F**: SILICON cable (200°C) ---- AWG24 X 2C X ϕ 4
 - P**: PVC (80°C) ---- AWG22
 - T**: TEFLON (200°C) ---- AWG24
 - X**: XLPE (125°C) ---- AWG22 (Standard)
- } For SA, SB, SC Type

TYPICAL WIRING DIAGRAMS

* AUTO SUPPLY CASE:
SINGLE FLOAT DUAL SWITCHES

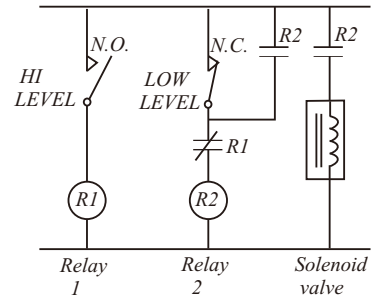
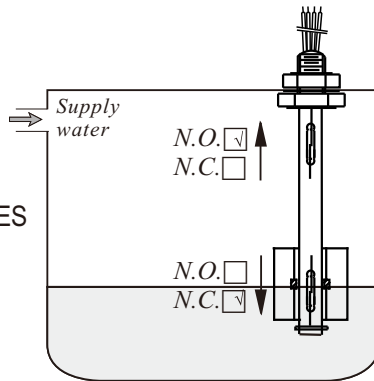

* AUTO DRAIN CASE:
SINGLE FLOAT DUAL SWITCHES

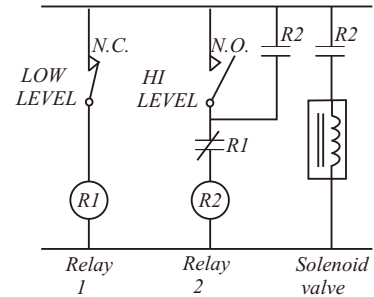
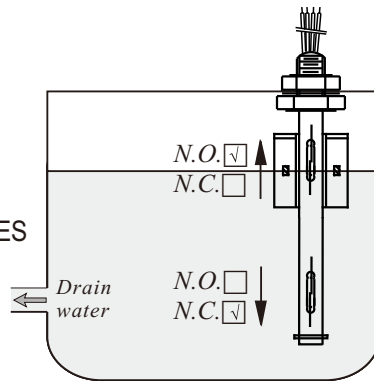

* AUTO SUPPLY CASE:
DUAL FLOATS DUAL SWITCHES

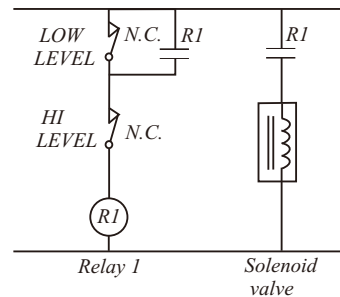
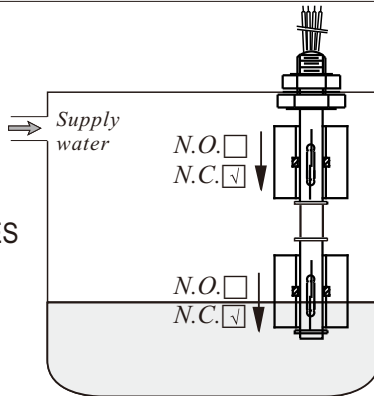

* AUTO DRAIN CASE:
DUAL FLOATS DUAL SWITCHES

